



GRAF



WORKBOOK

FIGURE SKATES COLLECTION

2024/25





Mauro Di Nardo
Head of Sales and Production

GRAF FIGURE / THE COMPANY

Designed to leave a mark. Since 1921.

Ice skates from Swiss production

GRAF Skates & Co. was established in Kreuzlingen in 1921 by Karl Graf's grandfather. GRAF Skates then produced a wide range of all kinds of sport shoes: from soccer, -bike, -hiking, up to tennis boots, etc. In 1937 the first ice skates were introduced and since 1974 GRAF Skates became specialists in ice hockey and figure skating boots.

85% of the skates produced by GRAF Skates AG in Switzerland are sold worldwide. Main markets amongst others are Russia, Scandinavia and Germany.

For the Japanese market ice skates are produced on particular lasts (shape of feet).

Expensive production

A high-quality ice skate is composed of many individual parts built together in a very complex way. Every stage of production from cutting out the boots, sewing,

lasting, gluing the sole and assembling the blades requires professionalism and specialized knowledge. It is only possible to produce such high quality goods at competitive prices with the investment of such special machines as GRAF Skates AG has. For the development of new models and technology, the input of customers and direct contacts with consumers are of high value. New products originate from customers inquiries, needs and co-creations by consumers. The testing of new materials is of great significance.

Quality comes to the fore

All employees of the GRAF Figure Company in Kreuzlingen, Switzerland work everyday to achieve the level of quality which GRAF Figure is known for.



MAXIMUM COMFORT FOR MAXIMUM PERFORMANCE

Anatomy of the GRAF Figure skate

Known figure skating champions have chosen GRAF Figure Skates. If you are aiming for success, your footwear should help you succeed. GRAF Figure has been offering cutting edge designs and materials since 1921, enabling you so to leave a mark with your performance.







- 1 Padded tongue
- 2 Tongue padding
- 3 Upper padding 3D
- 4 High quality microfibre lining (1,2 mm)
- 5 Additional Foam padding
- 6 Lace bite protection
- 7 Heel counter reinforcement & padding
- 8 Ankle padding
- 9 Footbed
- 10 Insole
- 11 Outsole
- 12 Upper material (Leather / Microfiber)
- 13 Toe reinforcement

Fit comes first - Special Order

This is our goal, because with personalized skates you can jump higher, turn more precisely, train longer and get better support. A GRAF Figure Special Order is worthwhile for skaters who want precisely fitted skates or are having trouble with stock skates. These skates are exclusively produced and handcrafted in Switzerland.

SOME POSSIBILITIES:

-  Only boots
-  Special width, skates according to tracings, heat molding
-  Extra-stiff/soft, special tongues
Material addition/changing
-  Reactivation of outdated models,
sole parts of other models
-  Different sizes L/R, heel padding
and many more



Many athletes count on the quality of a GRAF Figure Special Order. You can improve your performance, too! Ask your GRAF Figure dealer or send us an email to support@grafskates.ch.



Blade mounting

It is HIGHLY recommended that blade mounting be carried out by trained personnel. Blade mounting should be completed as follows.

- 1 Position the blade (commonly centered on the heel and sole but is subject to adjustment for each individual skater's preference) and mark the screw hole placement with a pen.
- 2 Drill the mounting holes at the marked points with a 2.5 mm // 3/32 in. drill bit. The holes in the heel must have a depth of no less than 15 mm // 19/32 in, the holes in the sole should be drilled through.
- 3 Secure the TOE PLATE of blade with GRAF screws. The HEEL should be secured with longer pan head screws provided

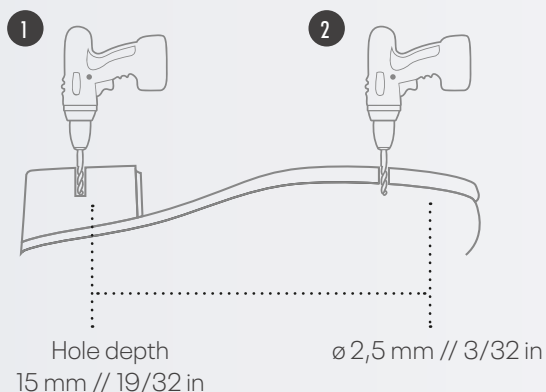
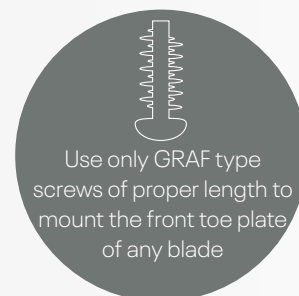

New GRAF Figure™ Ultralight outsole

The new GRAF Figure Ultralight-Outsole is the result of years of experience in production of skates and close cooperation with figure skating experts and athletes. It offers all the advantages of a classic GRAF Figure outsole with 26% reduction in weight. The most important improvement is the SRPP surface, which is also used on hockey skates. It is extremely lightweight, robust and offers a flat contact surface for easy blade mounting. Our tapered edge profile allows even more curve inclination without touching the ice. The ultralight-outsole will be used as a standard on all top level models and Richmond Special and can be ordered with GRAF Figure special orders.



26% lighter than classic outsole

Edmonton Special-Classic

The GRAF Figure Edmonton is our top of the line model and go-to for the majority of professional and competitive figure skaters. This model was originally designed to stand up to the harsh training rigours of Eastern Europeans. It lives up to the GRAF Figure brand by peak performance and durability among all figure skates available on the market.

Hand-selected full grain Italian leather is used exclusively for the upper (white model only). This is a top of the line model, ideal for Advanced, Juvenile and Senior Competitive Skaters. Upper made of first class leather laminated with heat-moldable reinforcement. Innovative OFC performance padding and inner liner.



DEGREE OF SUPPORT



ART. NR.	COLOUR	WIDTH	SIZE	SOLE
2597-20	White leather	S / M / L (S = On request)	2 - 9	UL SOLE
2597-28	Beige	S / M / L (S = On request)	2 - 9	UL SOLE

● Full sizes/Ganze Grössen/ Pointures entières

● Half sizes/Halbe Grössen/Demie pointures

S=Small M=Medium L=Large Width



Edmonton Special-Classic

Upper is made of First Class Box Leather or a High Performance Synthetic leather providing high side stability, NEW: Extra-light leather sole, professional model for the highest requirements.



DEGREE OF SUPPORT



ART. NR.	COLOUR	WIDTH	SIZE	SOLE
2597-19 / -29	Black velours	M / L (M = On request)	3 - 5.5 ◀ 6 - 12 ◀	UL SOLE
2697-19 / -29	Black leather	M / L (M = On request)	3 - 5.5 ◀ 6 - 12 ◀	UL SOLE

● Full sizes/Ganze Größen/ Pointures entières

◐ Half sizes/Halbe Größen/Demie pointures

S=Small M=Medium L=Large Width

Edmonton Special- V-Insert

Skating movements and jumps place extreme stress on a leather upper. The Special Order, built in V-INSERT, absorbs much of the impact and slows the breakdown of the boot. As an added benefit, V-INSERT's also make the break-in phase considerably easier.



DEGREE OF SUPPORT



ART. NR.	COLOUR	WIDTH	SIZE	SOLE
2597/V-20	White leather	S/M / L (S = On request)	3 - 9 ◀	UL SOLE
2597/V-29	Black velours	M / L (M = On request)	6 - 12 ◀	UL SOLE On request
2697/V-29	Black leather	M / L (M = On request)	6 - 12 ◀	UL SOLE On request

● Full sizes/Ganze Größen/ Pointures entières

◐ Half sizes/Halbe Größen/Demie pointures

S=Small M=Medium L=Large Width

LUKAS



BRITTSCHGI

LUKAS BRITTSCHGI

BORN 17. Februar 1998
Schaffhausen (SUI)

COMPETITION Men Single

TROPHYS

Gold
Swiss Championship 2019 /
2020 / 2022
CS Warschau Cup 2023

Bronze
European Championship 2023

Olympic Games 2022 23rd Ranking
World Championship 2021 15th Ranking
Grand Prix NHK Trophy 2023 3rd Ranking

WASHINGTON

Washington

GRAF Figure Washington EXTRA STIFF has the highest degree of stiffness available on special order and features a comfortable inner boot, well padded ankle area and upturned collar top end.

SPECIAL ORDER



DEGREE OF SUPPORT



ART. NR.	COLOUR	WIDTH	SIZE	SOLE
2598-20	White	S / M / L (S = On request)	3 - 9 ◀	UL SOLE
2598-29	Black velours	M / L (M = On request)	6 - 12 ◀	UL SOLE

● Full sizes/Ganze Größen/ Pointures entières ◐ Half sizes/Halbe Größen/Demie pointures S=Small M=Medium L=Large Width

Dance

Special model for icedancing with lower backstripe, made of first class leather (white model only) or microfiber leather, excellent side-stability.

DANCE



DEGREE OF SUPPORT



ART. NR.	COLOUR	WIDTH	SIZE	SOLE
2593-20	White	S / M / L (S = On request)	2 - 9 ◀	UL SOLE
2593-28	Beige	S / M / L (S = On request)	2 - 9 ◀	UL SOLE
2593-29	Black velours	M / L (M = On request)	5 - 11.5 ◀	UL SOLE On request

● Full sizes/Ganze Größen/ Pointures entières ◐ Half sizes/Halbe Größen/Demie pointures S=Small M=Medium L=Large Width



WINDSOR

Windsor

The Windsor, a perfect model for the skater that wants even more than the Edmonton Classic provides.

Windsor was developed for those that want all the Edmonton Special offers, but with a low cut back.

Offering excellent side stability and a padded low back for additional flexibility in the area of the Achilles tendon, the Windsor is made for advanced and professional skaters who are working on triple and quad jumps.



DEGREE OF SUPPORT



ART. NR.	COLOUR	WIDTH	SIZE	SOLE
2670-20	White	S / M / L (S = On request)	3 - 8	UL SOLE

● Full sizes/Ganze Grössen/ Pointures entières

● Half sizes/Halbe Grössen/Demie pointures

S=Small M=Medium L=Large Width

F4000

A medium stiffness boot with leather upper which was specifically developed utilizing a unique upper construction which provides good support and incorporates comfortable, soft ankle padding.



DEGREE OF SUPPORT



ART. NR.	COLOUR	WIDTH	SIZE	SOLE
2594-20	White	S / M / L (S = On request)	1 - 8	UL SOLE
2594-29	Black leather	M / L (M = On request)	6 - 12	UL SOLE On request

● Full sizes/Ganze Grössen/ Pointures entières

● Half sizes/Halbe Grössen/Demie pointures

S=Small M=Medium L=Large Width

Galaxy

Professional model for high level skaters. A skate made of extra light CP93 synthetic leather specifically developed for figure skates and innovative OFC performance padding and liner makes the boot extremely lightweight.



DEGREE OF SUPPORT



ART. NR.	COLOUR	WIDTH	SIZE	SOLE
2692-20	White	S / M / L (S = On request)	2 - 8 ◀	UL SOLE

● Full sizes/Ganze Grössen/ Pointures entières ◐ Half sizes/Halbe Grössen/Demie pointures S=Small M=Medium L=Large Width

Richmond Special

A medium stiffness skate made of extra light CP93 synthetic leather specifically developed for figure skates. Incorporating a comfortable padding that adapts optimally to the foot and utilizing «Ortho-Form Compound» Technology padding and inner lining to optimize fit.



DEGREE OF SUPPORT



ART. NR.	COLOUR	WIDTH	SIZE	SOLE
2591-0	White	S / M / L (S = On request)	10C-1.5 ● 2 - 8 ◐	UL SOLE
2591-19 / -29	Black Barnbox	M / L (M = On request)	13C - 1.5 ● 2 - 8 ◐	UL SOLE On request

● Full sizes/Ganze Grössen/ Pointures entières ◐ Half sizes/Halbe Grössen/Demie pointures S=Small M=Medium L=Large Width



Prestige Crystal

Base model for figure skating with upper made of genuine leather and high quality microfiber lining. Additional reinforcements for better support of the ankle.



Boots only
Nr.2589/NS-0

- Extra high upper construction for better support made of genuine leather
- Water-repellent Microfiber Inner Lining Flex Notch
- Soft Collar Backstay
- Mesh-Tongue with leather covering
- GRAF Figure UltraLight Outsole
- Heat-Moldable
- GRAF Figure Lausanne Figure Skating Blades attached by hand or Boots Only



DEGREE OF SUPPORT



ART. NR.	DESCRIPTION	COLOUR	WIDTH	SIZE	SOLE
2589-CR/SK	A4 / Lausanne (with Crystal)	White	M / L	10C - 12C(A4 Blade) ● 13C - 2.5 ◐ 3 - 9 ◐	UL SOLE
2589-CR/NS	Boots only (with Crystal)	White	M / L	10C - 9 ◐	UL SOLE
2589-19 / -29	Lausanne (no Crystal)	Black	L	1 - 5.5 ◐ 6 - 12 ◐	UL SOLE
2589/NS-19 / -29	Boots only (no Crystal)	Black	L	1 - 5.5 ◐ 6 - 12 ◐	UL SOLE

● Full sizes/Ganze Größen/ Pointures entières

◐ Half sizes/Halbe Größen/Demie pointures

S=Small M=Medium L=Large Width

Ruby Champion

Brand -new model for basic figure skating, made of genuine leather upper with an air active microfiber lining and excellent support and side stability.

- Well reinforced upper construction for great support
- Made of genuine leather
- Crystal decor
- Water-repellent Microfiber Inner Lining
- Flex Notch with extra Hook for additional Heel Look
- Soft Collar Backstay
- Mesh-Tongue with centered Lace Hook
- GRAF Figure UltraLight Outsole
- Heat-Moldable
- GRAF Figure Lausanne Figure Skating Blades attached by hand or Boots Only



DEGREE OF SUPPORT



ART. NR.	DESCRIPTION	COLOUR	WIDTH	SIZE	SOLE
2630/SK	Lausanne	White	M / L	2 - 8	UL SOLE
2630/NS	Boots only	White	M / L	2 - 8	UL SOLE

Full sizes/Ganze Größen/ Pointures entières

Half sizes/Halbe Größen/Demie pointures

S=Small M=Medium L=Large Width



Ruby Victory

A premium ice skate for ambitious skaters from the new Ruby line. The Ruby Victory is constructed with a synthetic upper, high-quality inner lining, and preformed ankle padding for the best comfort possible, with genuine Swarovski crystal décor and new design.



DEGREE OF SUPPORT



ART. NR.	DESCRIPTION	COLOUR	SIZE
2620	M-IV Blades	White	3-9

Half sizes/Halbe Größen/Demie pointures

Ruby Star

Starter skate for optimal comfort with soft padding and breathable inner lining. Genuine Swarovski crystal décor and new design.



DEGREE OF SUPPORT



ART. NR.	DESCRIPTION	COLOUR	SIZE
2610	A4 Blades	White	30-35 36-44

Full sizes/Ganze Größen/ Pointures entières

Ace

Youth model with upper made of synthetic leather and Microfiber Lining. Equipped with GRAF Figure Ultra Light UL-Outsoles and GRAF Figure A4 blades attached by hand with screws.



DEGREE OF SUPPORT



ART. NR.	DESCRIPTION	COLOUR	WIDTH	SIZE	SOLE
2577-10	A4 Blades	White	S / M (S = On request)	7C - 13C / 13.5C - 4.5	UL SOLE
2577/NS-10	Boots only	White	M / L	7C - 13C / 13.5C - 4.5	UL SOLE
2577-19	A4 Blades	Black	M / L (M = On request)	7C - 13C / 13.5C - 4.5	UL SOLE
2577/NS-19	Boots only	Black	M / L (M = On request)	7C - 13C / 13.5C - 4.5	UL SOLE

● Full sizes/Ganze Größen/ Pointures entières

● Half sizes/Halbe Größen/Demie pointures

S=Small M=Medium L=Large Width

Caprice

Medium stiff skate made of CP93 synthetic leather for figure skating. Comfortable Padding, that fits optimally around the foot. GRAF Figure M-IV premium blades attached by hand with screws.



DEGREE OF SUPPORT



ART. NR.	DESCRIPTION	COLOUR	WIDTH	SIZE	SOLE
2580-CR/SK-0	M-IV Blades	White	M / L (S = On request)	1-2.5 / 3 - 8	UL SOLE
2580-CR/NS-0	Boots only	White	M / L	1-2.5 / 3 - 8	UL SOLE
2580/SK-19	A4 Blades	Black	L (M = On request)	1 - 8	UL SOLE

● Full sizes/Ganze Größen/ Pointures entières

● Half sizes/Halbe Größen/Demie pointures

S=Small M=Medium L=Large Width



Boots only



Davos Gold

Recreational figure skates for occasional use. Made with reinforced upper of synthetic leather and breathable and quick drying «Air-Active» lining. Comes with stainless blades attached.



ART. NR.	COLOUR	SIZE
2170-01 / -02	White	25 - 35 ● 36 - 43 ●

● Full sizes/Ganze Größen/ Pointures entières

Bolero Crystal

Starter skate for optimal comfort with soft padding and breathable inner lining. Genuine Swarovski crystal decorative detail.



ART. NR.	COLOUR	SIZE
2175/CR-01 / -02	White	25 - 35 ● 36 - 44 ●
2175-29	Black	34 - 47 ●

● Full sizes/Ganze Größen/ Pointures entières

Arosa Gold

High quality leisure skate for ambitious skaters. Elegantly cut reinforced leather upper and fitted with high quality blades attached with screws by hand.



ART. NR.	COLOUR	SIZE
2275	White	27 - 35 ● 36 - 43 ●

● Full sizes/Ganze Größen/ Pointures entières

Revue Top

High-durability recreational skate based on GRAF Figure rental skate design. Extra comfort and warming wool lining. GRAF Figure A4 blades attached by hand.



ART. NR.	COLOUR	SIZE
2285-02	White	36 - 43 ●

● Full sizes/Ganze Größen/ Pointures entières

VADIM

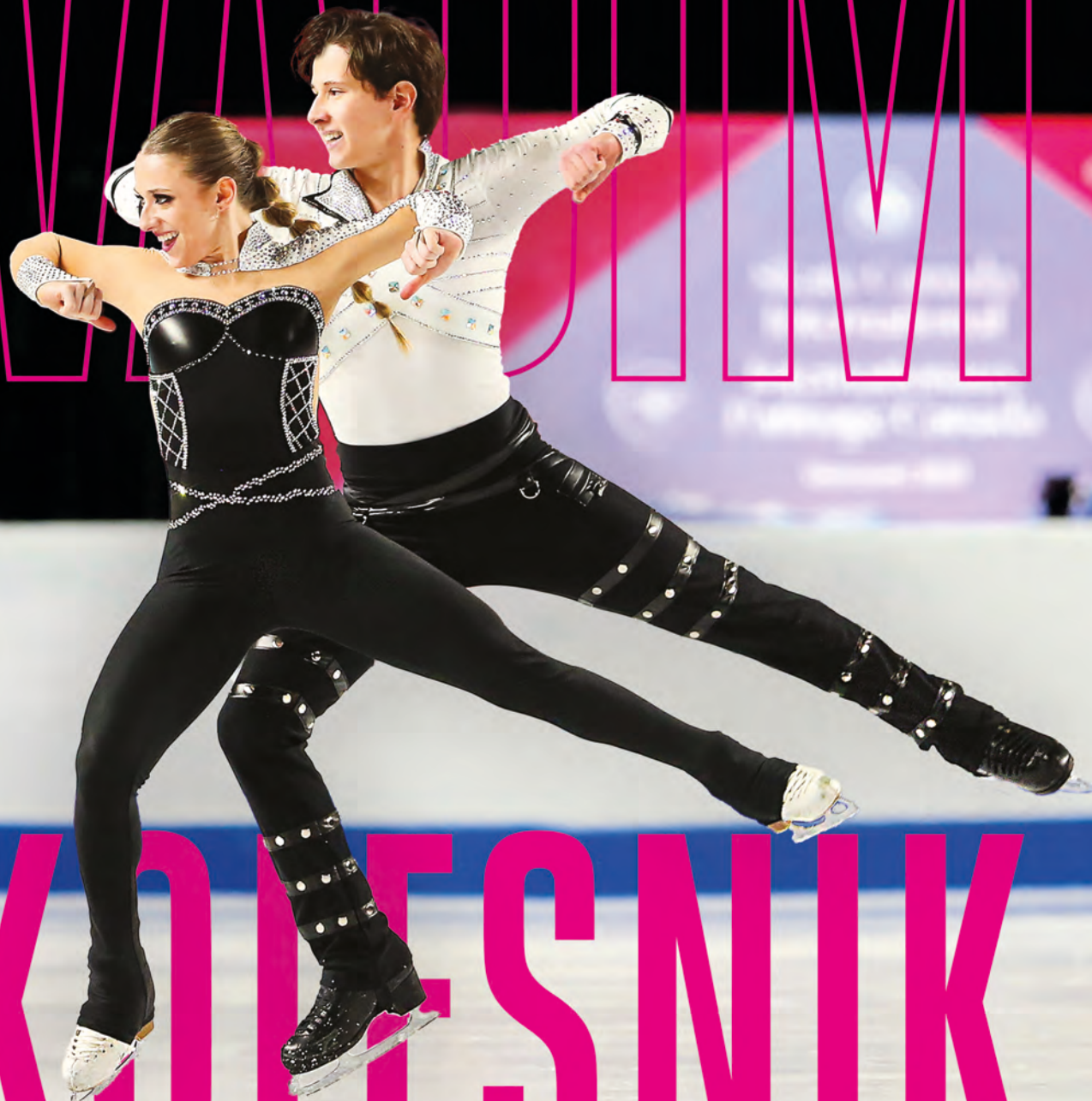

KOLESNIK

VADIM KOLESNIK/
EMILEA ZINGAS

BORN 27. October 2001
Kharkiv Ukraine

TROPHYS Gold
U.S. Ice Dance Final 2022

Bronze
CS Golden Spin of Zagreb 2022

U.S. Championship 2023 4th Ranking
Skate Canada Int. 2023 5th Ranking
Gran Prix Espoo 2023 5th Ranking

COMPETITION Ice Dancing

Arosa Gold Inline

High quality leisure skate for ambitious skaters. Elegantly cut reinforced leather upper and fitted with «ONE» figure skating frame attached with screws by hand.



ART. NR.	COLOUR	SIZE
2275/IC	White	34 - 35 ● 36 - 43 ●

● Full sizes/Ganze Größen/ Pointures entières

Caprice Inline

Medium stiff skate made of CP93 synthetic leather for figure skating. Comfortable padding, that fits optimally around the foot. GRAF «ONE» figure skating frame attached with screws by hand.



DEGREE OF SUPPORT

● ○ ○ ○ ○ ○

ART. NR.	DESCRIPTION	COLOUR	WIDTH	SIZE	SOLE
2580-CR/IC-0	Inline Chassis	White	M / L (S = On request)	2 - 8 ◀	UL SOLE
2580-CR/IC-19	Inline Chassis	Black	L (M = On request)	2 - 8 ◀	UL SOLE

● Full sizes/Ganze Größen/ Pointures entières

● Half sizes/Halbe Größen/Demie pointures

S=Small M=Medium L=Large Width



Blades

JUNIOR COMP

«Start me up You'll never stop»
Advanced Performance for free-style skating



ART. NR.	DESCRIPTION	RADIUS
4270	Parallel Blade/ Rocker - Hollow	8' - 7/16"

LAUSANNE

“Winning Formula” Advanced Junior
Performance for free-style skating



ART. NR.	DESCRIPTION	RADIUS
4265	Parallel Blade/ Rocker - Hollow	8' - 7/16"

SILVER STAR

A high quality mid-range parallel blade
for professionals



ART. NR.	DESCRIPTION	RADIUS
4275	Parallel Blade/ Rocker - Hollow	7' - 5/8"

DIAMOND SE

«Power and Aesthetic Refinement»
High Performance for free-style skating.



NEW
SPECIAL EDGE
DESIGN

ART. NR.	DESCRIPTION	RADIUS
4285/SE	Taper (Hollow) Blade	8' - 7/16"

PLATINUM

«Yours to discover» Advanced High Performance
for freestyle skating



ART. NR.	DESCRIPTION	RADIUS
4280	Parallel Blade/ Rocker - Hollow	8' - 7/16"

DANCE

A top quality dance blade, parallel slimline edge
for increased glide.



ART. NR.	DESCRIPTION	RADIUS
4290/SE	Parallel BLADE (reduced Skating edge)	8' - 5/8"

CYBER STAR

A top range free skating blade of the highest quality.
Enlarged top toe pick for precise toe spotting.



ART. NR.	DESCRIPTION	RADIUS
4282	Parallel Blade/ Rocker - Hollow	7' - 5/8"

John Wilson
THE WORLD'S BEST BLADES



Official distributor

Blade Covers

FUZZY KL/LEOPARD



ART. NR.	SIZE
4912ST-LEOP	L-XL

FUZZY KL/LEOPARD SHORT FIBERS



ART. NR.	SIZE
4910-LEOP	S-M/L-XL

FUZZY KL/TIGER GOLD SHORT FIBERS



ART. NR.	SIZE
4910-GOTIG	S-M

FROTTÉ KL/ PINK SHORT FIBERS



ART. NR.	SIZE
4907-60	S-M/L-XL

FUZZY KL/PANDA



ART. NR.	SIZE
4912ST-PDA	L-XL

FUZZY KL/TIGER BLUE SHORT FIBERS



ART. NR.	SIZE
4910-BLTIG	S-M

FROTTÉ KL/ROYAL BLUE SHORT FIBERS



ART. NR.	SIZE
4910-44	S-M/L-XL

FROTTÉ KL/ YELLOW FLUO SHORT FIBERS



ART. NR.	SIZE
4907-55	S-M/L-XL

FUZZY KL/DALMATIAN SHORT FIBERS



ART. NR.	SIZE
4910-DALM	L-XL

FUZZY KL/ ZEBRA SHORT FIBERS



ART. NR.	SIZE
4910-ZEB	S-M

FUZZY KL/ PANTHER SHORT FIBERS



ART. NR.	SIZE
4910-PAN	S-M

FROTTÉ KL/ BLACK SHORT FIBERS



ART. NR.	SIZE
4907-9	S-M/L-XL



Blade Covers

UNIVERS PROTECTION GLITTER

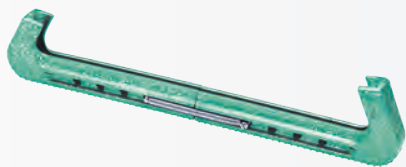

ART. NR.	COLOUR
4902	Gold/Blue/Green/Fuxia Silver

UNIVERS PROTECTION



ART. NR.	DESCRIPTION	COLOUR
4901	P.PAIR FROTTÉ KL/ YELLOW FLUO SHORT FIBERS	Red/yellow/blue/green/ black/white/silver

PROTECTION WITH FEATHER WHITE COLOR



ART. NR.	DESCRIPTION
4900-FE	P.PAIR

PROTECTION WHITE COLOR



ART. NR.	DESCRIPTION
4900-0	P.PAIR

SEQUIN



ART. NR.	SIZE
4914-SE	L-XL

SOAKER PUFFY



ART. NR.	SIZE
4913-1	L-XL

FUZZY KL/TIGER GOLD SHORT FIBERS



ART. NR.	SIZE
4909-GOTIG	L-XL

FUZZY KL/TIGER BLUE SHORT FIBERS



ART. NR.	SIZE
4909-BLTIG	L-XL

FUZZY KL/ PANTHER SHORT FIBERS



ART. NR.	SIZE
4909-PAN	L-XL

Accessories

BOTTLE



ART. NR.	SIZE
49450	0,7lt

LACES BLACK



ART. NR.	DESCRIPTION	SIZE
4132-9	PAIR	280 cm
4132-9	PAIR	305 cm

LACES WHITE

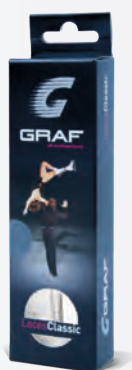

ART. NR.	SIZE
4132-0	220 cm
4132-0	250 cm
4132-0	280 cm
4132-0	305 cm

LACES BEIGE



ART. NR.	DESCRIPTION	SIZE
4132-8	PAIR	250 cm
4132-8	PAIR	280 cm
4132-8	PAIR	305 cm

GLOVES



ART. NR.	SIZE	ART. NR.	SIZE	ART. NR.	SIZE	ART. NR.	SIZE	ART. NR.	SIZE	ART. NR.	SIZE
45110-06	M	45110-55	M	45110-11	M	45110-66	M	45110-9	S/M/L	45110-8	S/M/L

GLOVES STRASS



ART. NR.	SIZE	ART. NR.	SIZE
45112-08	S/M/L	45112-09	S/M/L



Accessories

- Navicular Bone Support: Your position in the shoe is always in line
- Constant pressure distribution on skates
- Reduced fatigue of ankle joint
- Centered power transmission to blades and ice
- Eudermic material and quick drying



GRAF ANATOM FIT



ART. NR.	SIZE
49152-1/-2	11c-2

GRAF PERFORMANCE INSOLE



ART. NR.	SIZE
49154-1/-2	1-12

GRAF FIGURE CLASSIC INSOLE



ART. NR.	SIZE
49126-1/-2	1-12

Accessories - INLINE

«ONE» FIGURE SKATING FRAME



ART. NR.	SIZE
57510/98	215-265

FIGURE OUTDOOR WHEELS



ART. NR.	SIZE
57410/82A-0	68 mm

FIGURE RUBBER STOPPER (KIT -2 PCS.)



ART. NR.	SIZE
57810/00-0	One size

FIGURE SPACER AND AXLES



ART. NR.	SIZE
574890	One Size

BEARING ABEC 9 (KIT- 12 PCS.)SET)



ART. NR.	SIZE
57320	One Size

BEARING ABEC 11 (KIT- 12 PCS.)



ART. NR.	SIZE
57320	One Size

Bags

TROLLEYBAG WITH WHEELS



ART. NR.	SIZE	COLOUR
4030-61	48 x 34 x 27 cm	Red-white



ART. NR.	SIZE	COLOUR
4030-90	48 x 34 x 27 cm	Black-white (Security Reflector)

SPORT BAG



ART. NR.	SIZE	COLOUR
4032-66	33 x 44 cm	Pink
4032-90	33 x 44 cm	Black

SHOULDER BAG



ART. NR.	SIZE	COLOUR
4007-3	38 x 24 x 34 cm	Viola



ART. NR.	SIZE	COLOUR
4007-46	38 x 24 x 34 cm	Azur



ART. NR.	SIZE	COLOUR
4009-4	38 x 24 x 34 cm	Blue
4009-9	38 x 24 x 34 cm	Black

DUFFLE - BAG



ART. NR.	SIZE	COLOUR
4033-9	100 x 40 x 42 cm	black



Seamless Leggings Broken Ice

- 3D seamless technology
- Comfortable waist band
- Extra-soft microfiber yarn
- Weight: 85 g - 3,0 oz.
- Material: 94% Polyamide - 6% Elastane



ART. NR.	SIZE	COLOUR
45135-04	J2 - J4	Sky Blue
45135-06	J2 - J5	Fuxia
45135-7	J2 - J4	Orange
45135-62	J2 - J4	Raspberry



Seamless Performance Shirt/Broken Ice

- Seamless technology
- Smooth flatlock seams for increased comfort
- 3D High elasticity
- Ergonomic lightweight natural stretch with breathable nets and mesh insert
- Extreme moisture absorption and heat insulation
- Weight: 150 g - 3,0 oz.
- 52% Polypropylene, 45% Polyamide, 3% Elastane



ART. NR.	SIZE	DESCRIPTION	COLOUR
45225-04	XS/S/M/L	Broken Ice	Blue
45225-06	XS/S/M/L	Broken Ice	Orange
45225-09	XS/S/M/L	Broken Ice	Black
45120-8 /-9	J1 - J5	Turtleneck	-8 Skin / -9 Black
45122-8 /-9	J1 - J5	Round neck	-8 Skin / -9 Black



- 1 Medium Compression
- 2 Thermal Insulation
- 3 Flat Lock Seam
- 4 3D Comfort Stretch Fabric
- 5 Jersey Integrated waist band

Turtle/Round Neck Body

- Seamfree longsleeve round neck bodysuit
- High stretch 3D material
- Moisture management
- Thermally insulating
- Plastic botton snaps anti allergic
- Weight: 80 g - 2,8 oz.
- Material: 90% Nylon - 10% Elastane

ART. NR.	SIZE	DESCRIPTION	COLOUR
45120-8 /-9	J1 - J5	Body Turtle neck	-8 Skin/ -9 Black
45122-8 /-9	J1 - J5	Body Round neck	-8 Skin/ -9 Black



70 Denier Tights

- 70 den
- 3D technology
- Comfortable waist band
- Extra-soft microfiber yarn
- Body color match
- Material: 93% Nylon - 7% Elastane

ART. NR.	SIZE	DESCRIPTION	COLOUR
45140-8	6-9/10-12/S/M/L	Footed	Skin colour
45142-8	6-9/10-12/S/M/L	Over Boot	Skin colour
45144-8	S/M/L	Velcro	Skin colour

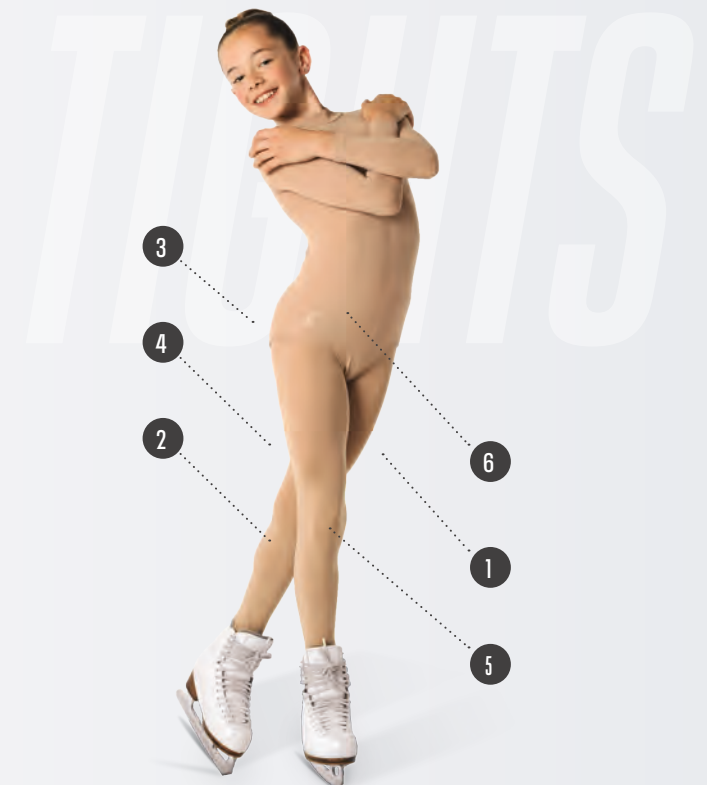

- 1 Medium Compression
- 2 Thermal Insulation
- 3 Flat Lock Seam
- 4 3D Comfort Stretch Fabric
- 5 Jersey Integrated waist band



Seamless Leggings

- 3D seamless technology
- Comfortable waist band
- Extra-soft microfiber yarn
- Weight: 85 g - 3,0 oz.
- Material: 94% Nylon - 6% Elastane

SEAMLESS



ART. NR.	SIZE	DESCRIPTION	COLOUR
45130-9	J1- J5	Leggings/Black overheel	Black
45132-9	J2- J5	Leggings/Black	Black
45134-04	J2- J5	Leggings/Sky blue	Sky-Blue
45134-06	J2- J5	Leggings/Fuxia	Fuxia



Seamless Performance Shirt

- Seamless technology
- Smooth flatlock seams for increased comfort
- 3D High elasticity
- Ergonomic lightweight natural stretch with breathable nets and mesh insert
- Extreme moisture absorption and heat insulation
- Weight: 150 g - 3,0 oz.
- Material: 79% Nylon, 18% Polypropylen, 3% Elastane



ART. NR.	SIZE	COLOUR
45220-04	XS/M/L	Sky blue
45220-9	XS/M	Black
45220-06	XS/S/M/L	Fuxia



- 1 Medium Compression
- 2 Thermal Insulation
- 3 Flat Lock Seam
- 4 3D Comfort Stretch Fabric
- 5 Jersey Integrated waist band

Skate size conversion table

BOOT SIZE UK	7C	8C	9C	10C	11C	12C	13C	13,5C	1	1.5	2	2.5	3	3.5	4	4.5
FR	24 ^{1/3}	25 ^{1/3}	26 ^{1/3}	28	29 ^{1/3}	30 ^{1/3}	31 ^{1/3}	32 ^{1/3}	33	33 ^{1/3}	34 ^{1/3}	34 ^{2/3}	35 ^{1/3}	36	36 ^{2/3}	37 ^{1/3}
MAX FOOT LENGTHS	151	155	164	173	181	189	197	201	206	211	215	219	223	227	231	235

BOOT SIZE UK	5	5.5	6	6.5	7	7.5	8	8.5	9	9.5	10	10.5	11	11.5	12
FR	38	38 ^{2/3}	39 ^{1/3}	40	40 ^{2/3}	41 ^{1/3}	42	42 ^{2/3}	43 ^{1/3}	44	44 ^{2/3}	45 ^{1/3}	46	46 ^{2/3}	47 ^{1/3}
MAX FOOT LENGTHS	240	245	249	253	257	261	265	270	274	279	283	287	291	295	299

● Full sizes/Ganze Größen/ Pointures entières

● Half sizes/Halbe Größen/Demie pointures

S=Small M=Medium L=Large Width

Boot blades

BOOT SIZE UK	13C	1	1.5	2	2.5	3	3.5	4	4.5	5	5.5	6	6.5	7	7.5	8	8.5	9	9.5	10	10.5	11	11.5	12
FR	31 ^{2/3}	33	33 ^{1/3}	34 ^{1/3}	34 ^{2/3}	35 ^{1/3}	36	36 ^{2/3}	37 ^{1/3}	38	38 ^{2/3}	39 ^{1/3}	40	40 ^{2/3}	41 ^{2/3}	42	42 ^{2/3}	43 ^{1/3}	44	44 ^{2/3}	45 ^{1/3}	46	46 ^{2/3}	47 ^{1/3}
SOLE LENGTH (INCH)	205	213	220	227	230	233	237	243	246	249	253	257	262	264	269	272	279	280	285	288	293	297	300	303
BLADE SIZE (INCH)	8	8 ^{1/4}	8 ^{1/4}	8 ^{1/2}	8 ^{3/4}	8 ^{3/4}	9	9 ^{1/4}	9 ^{1/4}	9 ^{1/2}	9 ^{3/4}	9 ^{3/4}	10	10	10 ^{1/4}	10 ^{1/4}	10 ^{1/2}	10 ^{3/4}	10 ^{3/4}	11	11	11 ^{1/4}	11 ^{1/4}	11 ^{1/2}

Nominal values: real sizes may vary by pair of skates.

Seamless leggings/broken ice Seamless leggings

↖ SIZE	↻ AGE	↕ HEIGHT
J1	4-6	104-120 cm/3'4"-3'9"
J2	7-9	120-134 cm/3'9"-4'4"
J3	10-12	134-152 cm/4'4"-5"
J4	13-15	152-167 cm/5"-5'5"
J5	16-18	167-180 cm/5'5"-5'9"

Seamless performance shirt/broken ice Seamless performance shirt

↖ GRAF FIGURE SIZE	↖ SIZE	↕ HEIGHT
XS	32-34	140-150 cm
XS (Performance shirt)	34-36	140-150 cm
S	36-38	158-166 cm
M	38-40	164-170 cm
L	42-44	168-174 cm

70 Denier tights

↖ SIZE	↻ AGE	↕ HEIGHT
J1	6-9	110-130 cm/3'6"-4'2"
J2	10-12	135-140 cm/4'4"-4'6"
J3	S	145-160 cm/4'7"-5'2"
J4	M	160-170 cm/5'2"-5'5"
J5	L	165-180 cm/5'4"-5'9"



GRAF FIGURE WORLDWIDE

GRAF SKATES AG
Wiesenstrasse 1
CH-8280 Kreuzlingen
T +41 (0) 71- 672 57 57
support@grafskates.ch

GRAF SKATES GmbH
Lindauerstrasse 1
DE-86842 Türkheim
T +49 (0) 8346-9824630
info@graf-skates.de

SILECKY SPORTS, INC.
31 East Reid Place
Verona, New Jersey 07044
T +1 (973) 704-0302
matej.silecky@grafskates.ch